

APM-200

User Manual



Content

A.Components	1
<hr/>	
B.H/W Parts	
i. Both Sides	2
ii. Settings	3
<hr/>	
C.System Settings	
i. Date & Time	5
ii. Wi-Fi	7
iii. Screen Timeout	8
iv. Language	9
<hr/>	
D. Application	
i. Settings	10
ii. Full Diagnosis	
CRM	11
Hair Loss Status	13
Scalp Status	14
Keratin of Scalp	15
Exposure of Scalp's Vessel	16
Hair Thickness	17
Hair Pore Status	19
Cuticle Status	20
Result	21
Send Result	
i. Email	22
ii. Mirroring	24
<hr/>	
E. Troubleshooting & FAQ	25
<hr/>	
F. Warranty	27

Components

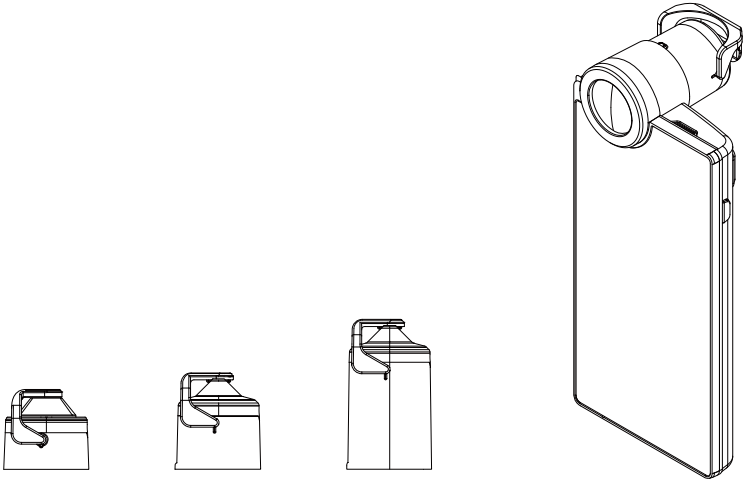

lens (APM 202) lens (APM 203) lens (APM 204) Main unit with hair lens(APM-200)

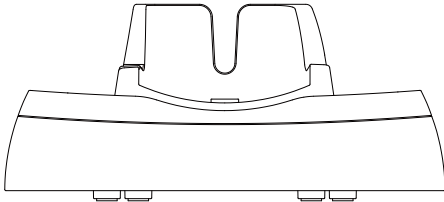

Cradle



Battery (2EA)

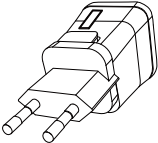

Charger

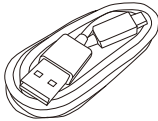

USB cable

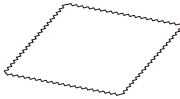

Cleaning cloth

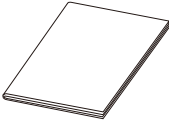

Manual

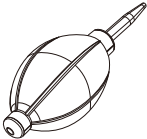

Air blower

H/W Parts

Both Sides

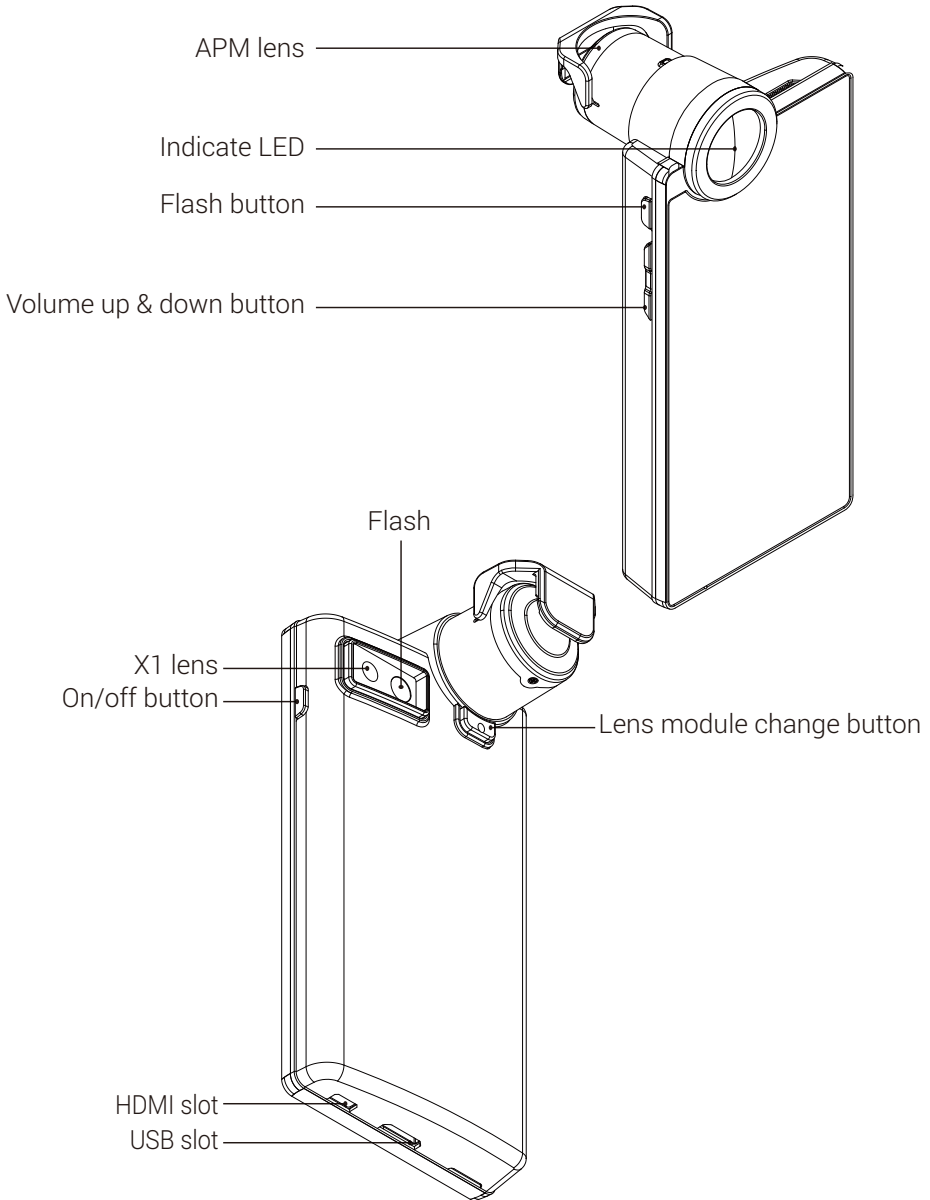

H/W Parts

Settings

Insert the battery

- 1 Open the battery cover by pushing it up with finger.
- 2 Insert the battery and gently press the battery into place.
- 3 Close the cover.

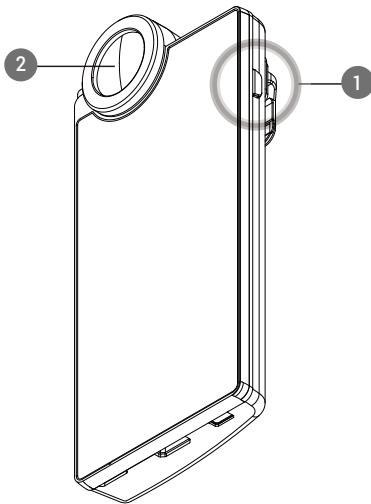
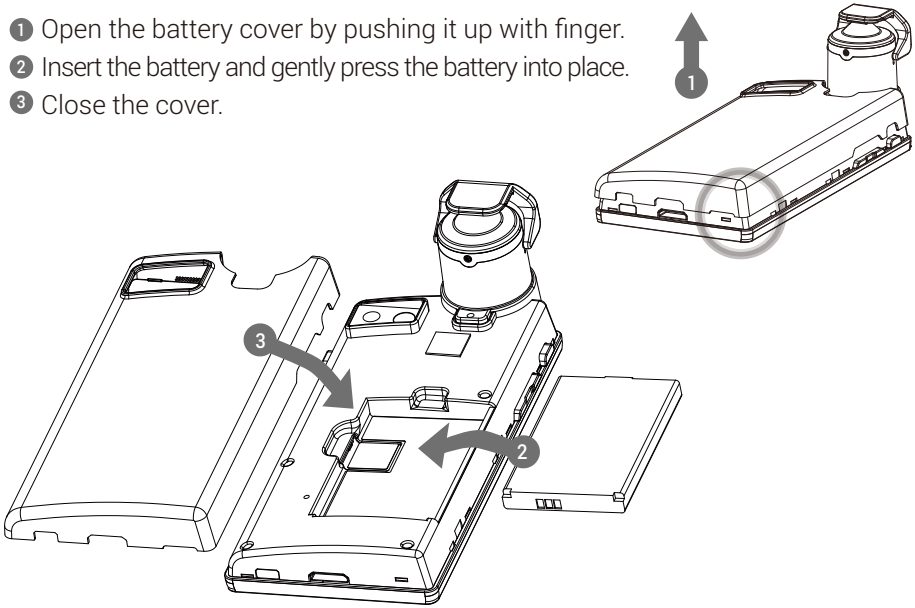

To turn on & off the power

- 1 Press and hold "power" button.
- 2 Then "Indicate LED" will be twinkled and turned on white.

H/W Parts

Settings

**Charger can be used for American type & European type.
The default is European type .**

- 1 Push the plug up.

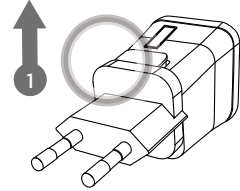

- 2 Then 220V European type is disassembled and you can see the 110V-220V American type inside of the charger.

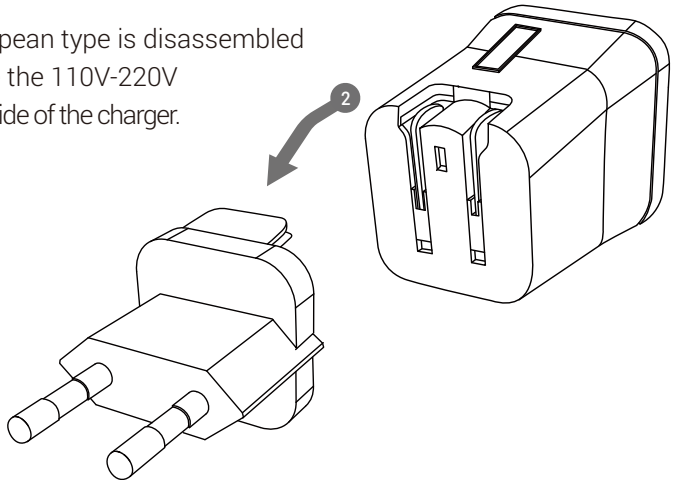

- 3 Choose the one you want to use and connect USB cable in adaptor.

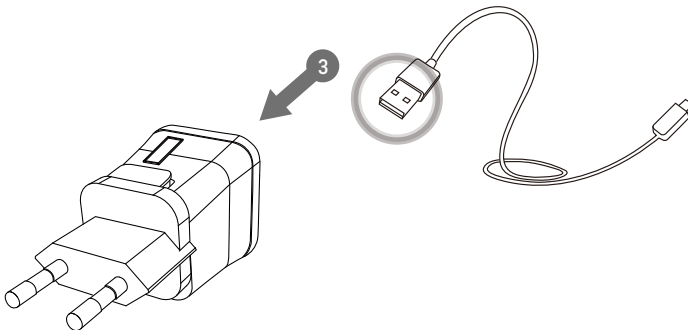

System Settings

Date & Time

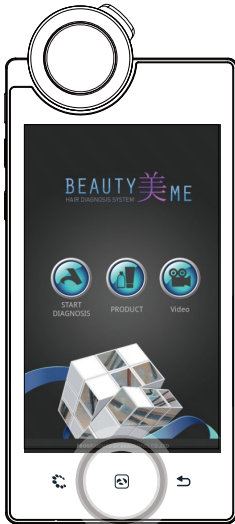

1 Press  button.



2 Touch  button.

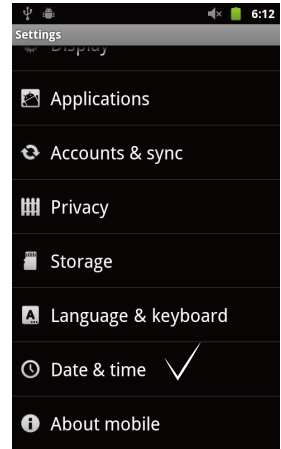

3 Touch "Date & time".

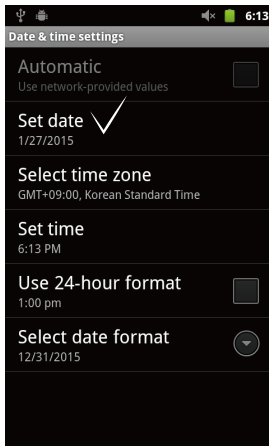

4 Touch "Set date".

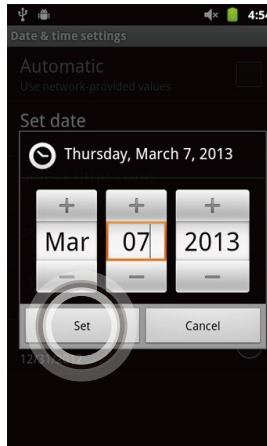

5 Change the date and touch "Set" button.

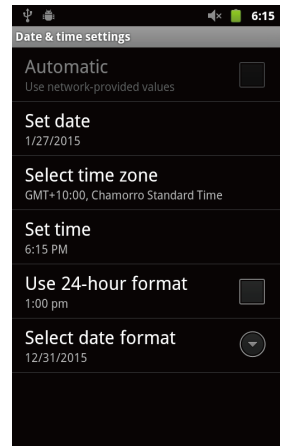

6 Please check the setting is correctly applied.

System Settings

Date & Time

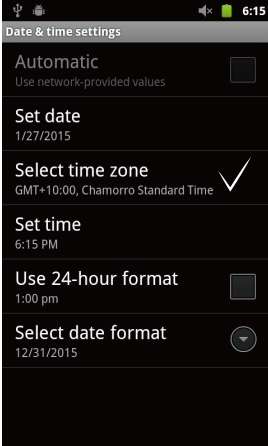

7 Touch "Select time zone" button.



8 Change into the current time zone .

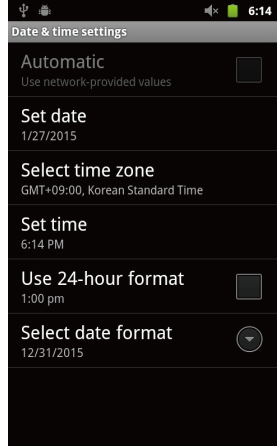

9 Please check the setting is correctly applied.

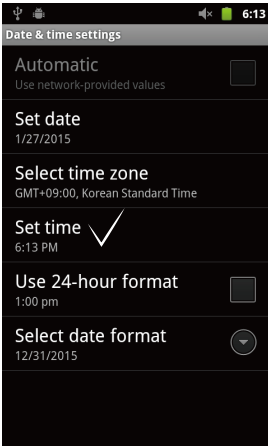

10 Touch "Set time".

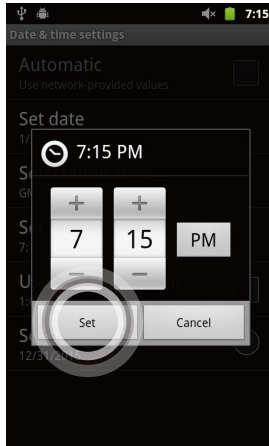

11 Change into the current time and touch "Set" button.

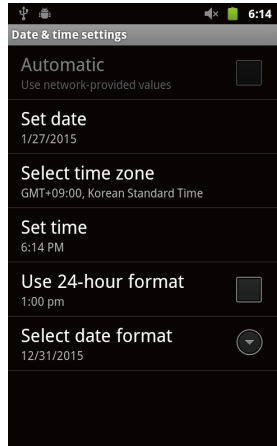

12 Please check the setting is correctly applied.

System Settings

Wi-Fi

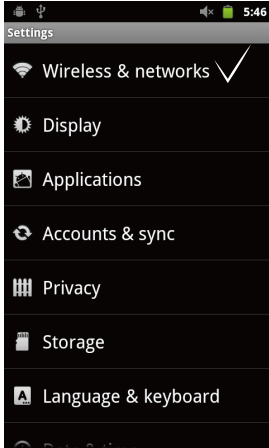

1 Touch "Wireless & networks".

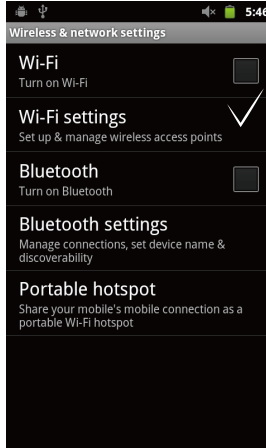

2 Touch "Wi-Fi settings".

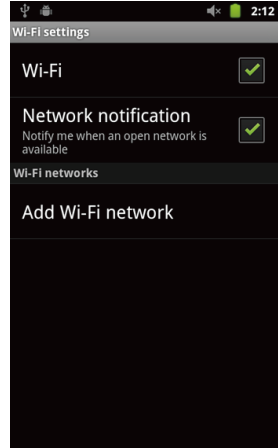

3 Check the square box.

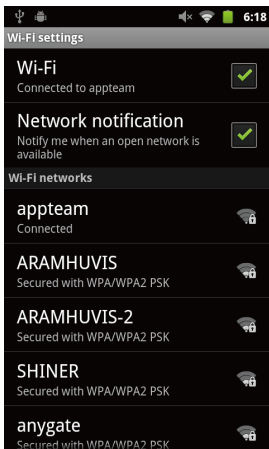

4 Wi-Fi list will be appeared.

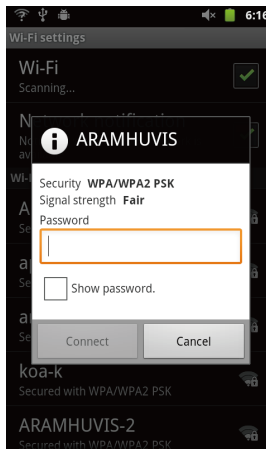

5 Among the lists, select the Wi-Fi connection you could use.

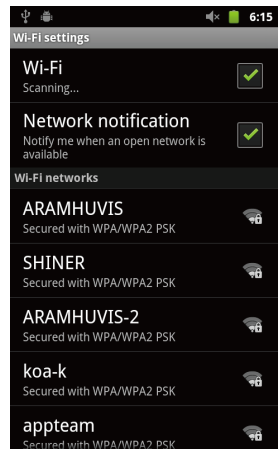

6 Wait until the device is connected to with Wi-Fi.

System Settings

Wi-Fi



- 7 Once the device is connected to Wi-Fi, you can see the Wi-Fi signal as left image.

Wi-Fi Usage

- E - mail
In order to send the analysis data.
- Software update
In order to update the software version.

Screen Timeout

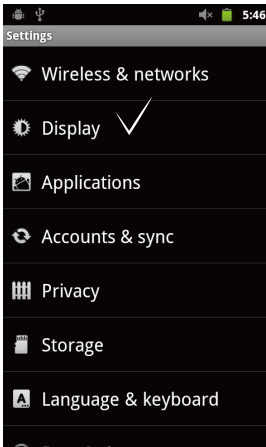

- 1 Touch "Display".

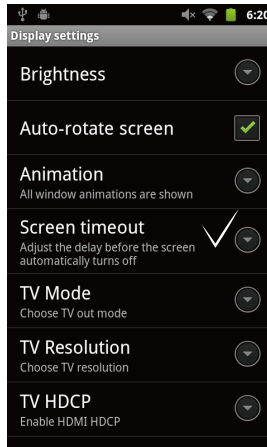

- 2 Touch "Screen timeout".

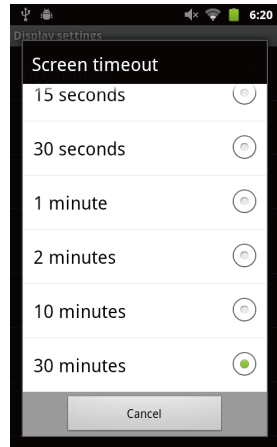

- 3 Touch the time you want to set.

System Settings

Language

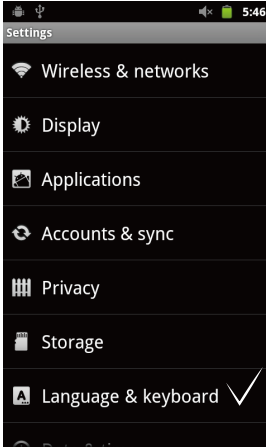

1 Touch "Language & keyboard".



2 Touch "Select language".

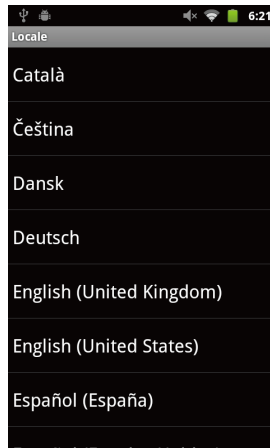

3 Among the lists, touch your language.

Application

Settings

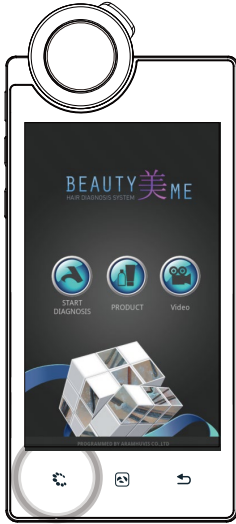

1 Press  button.

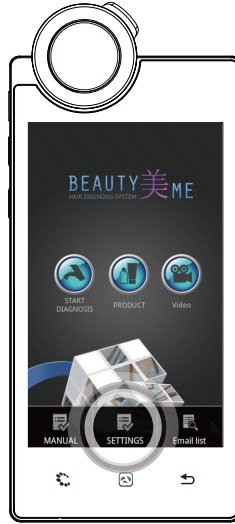

2 Touch "SETTINGS".

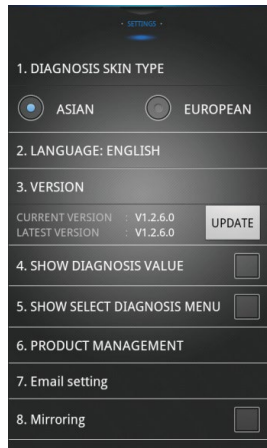

3 Language, version , email setting is available.

Application

CRM - Full

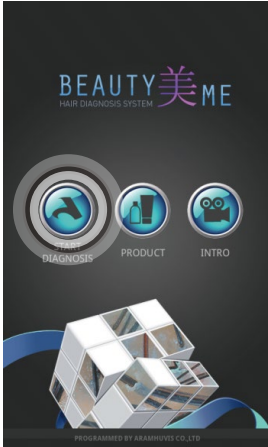

1 Touch "START DIAGNOSIS".



2 Touch "FULL DIAGNOSIS".

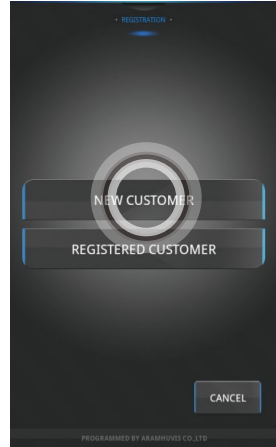

3 If you are new customer, touch "NEW CUSTOMER".

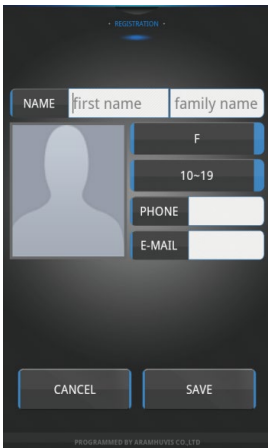

4 Input the information as below.
- Full Name, Phone Number, Email address
- Gender and age group

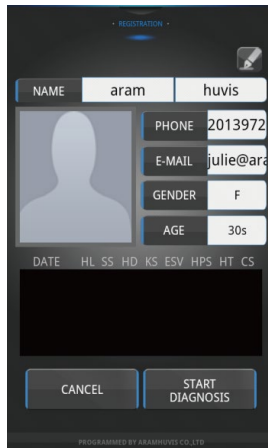

5 After registering all information, touch "SAVE" button.

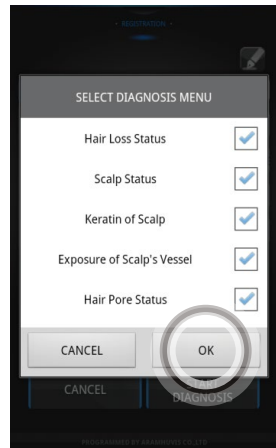

6 Check the diagnosis menu and touch "OK".

Application

CRM - Simple



1 Touch "SIMPLE DIAGNOSIS" button.



2 Select the "GENDER" and "AGE" group.

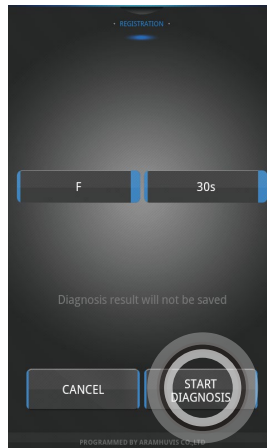

3 "START DIAGNOSIS"

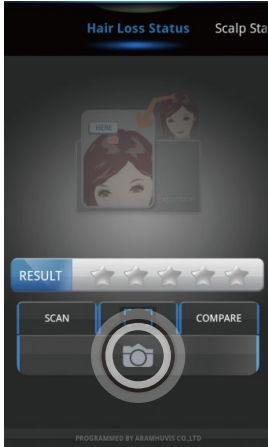

Application

Hair Loss Status

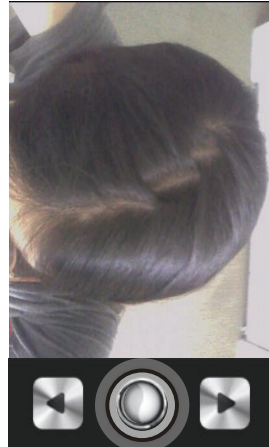

1 Touch  to activate camera.



2 Touch  to take image and use  or  to adjust focus.



3 Touch "SCAN" to diagnosis.

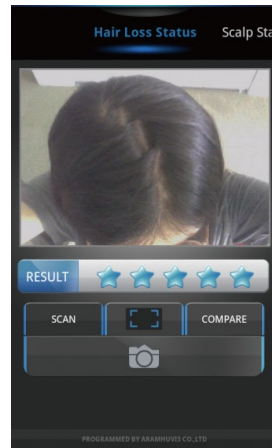



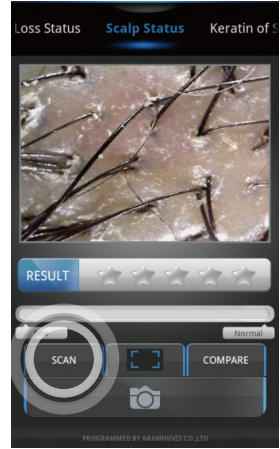

4 Check the result.

Application

Scalp Status



- ① Touch  to activate camera.
- ② Touch  to take image and use  or  to adjust focus.
- ③ Touch "SCAN" to density mode.

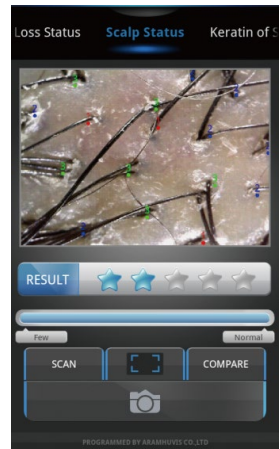
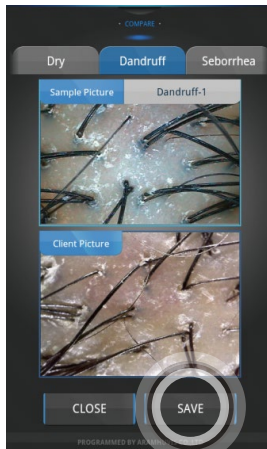
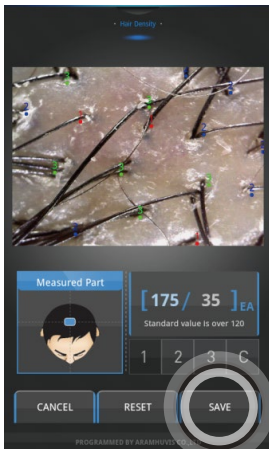

- ④ Touch save to density data.
 - Count number of hair by touching "1,2,3".
 - Touch "C" to undo previous execution.
 - Touch "RESET" to clear all.
- ⑤ Touch "SAVE" to comparison data.
 - Fling the menu to see different type.
 - Touch the top reference image to see different type of scalp under menu.
- ⑥ Check the result.

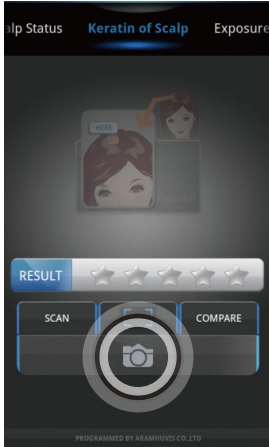

Application

Keratin of Scalp



1 Touch  to activate camera.



2 Touch  to take image and use  or  to adjust focus.

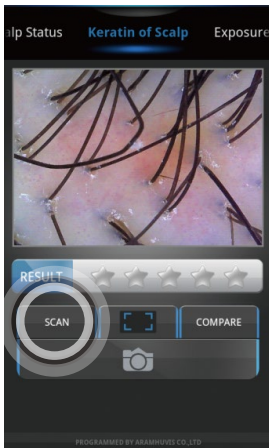

3 Touch "SCAN" to measure.

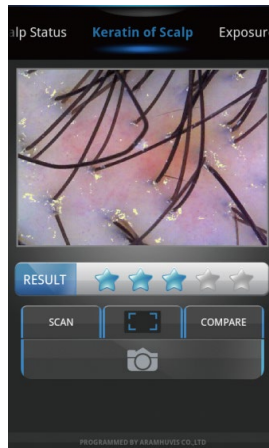

4 Check the result.

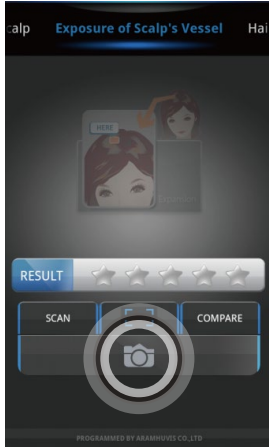

Application

Exposure of Scalp's Vessel



1 Touch  to activate camera.



2 Touch  to take image and use  or  to adjust focus.

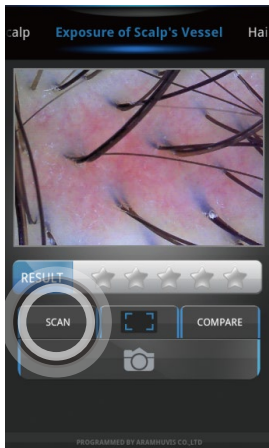

3 Touch "SCAN" to analyze.

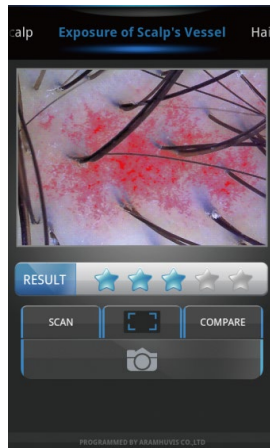

4 Check the result.

Application

Hair Thickness - Auto Measurement

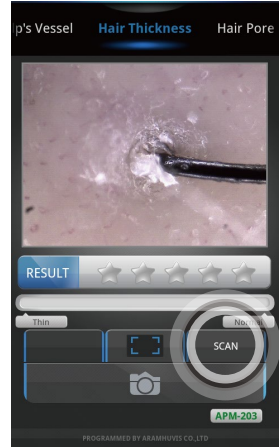
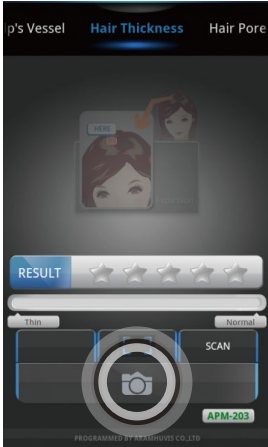

- 1 Touch  to activate camera.
- 2 Touch  to take image.
- 3 Touch "SCAN" to measure the hair thickness.

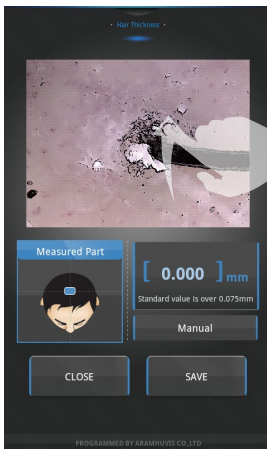

- 4 Please mark the hair area point near the top image.

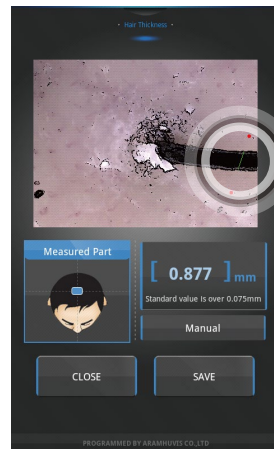

- 5 The program will automatically calculate the hair distance within range.

Application

Hair Thickness - Auto Measurement

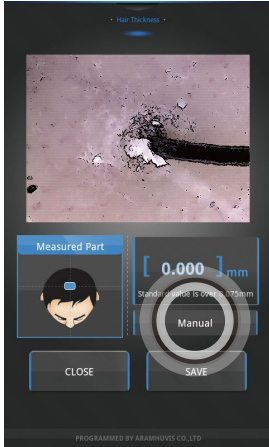

- 1 Touch "Manual" to measure the hair thickness.
- 2 Move the white square into the range you want to measure.
- 3 Touch the range and touch "SAVE".

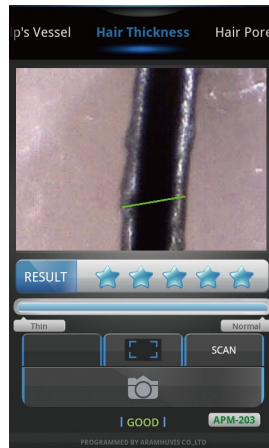
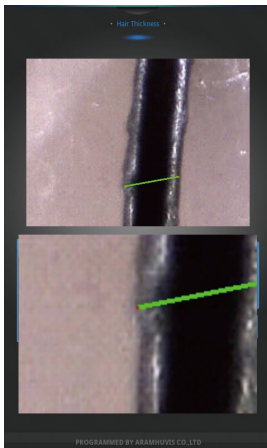

- 4 Once you touch the screen to measure, you will find the new tabs in order to make sure where you are touching.
- 5 Check the result.

Application

Hair Pore Status

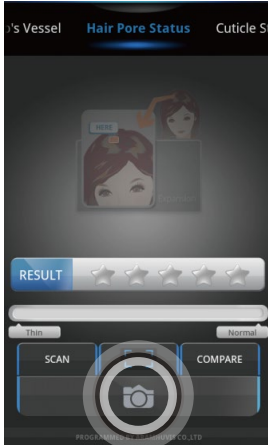

1 Touch  to activate camera.

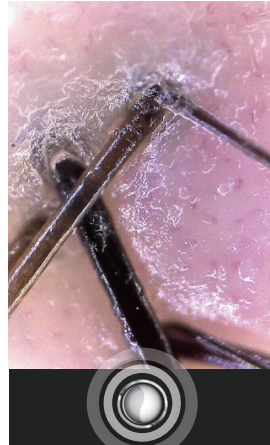

2 Touch  to take image.



3 Touch  to full image.
Touch "COMPARE" to compare mode.

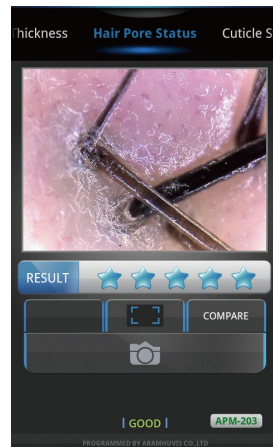

4 Check the result.

Application

Cuticle Status

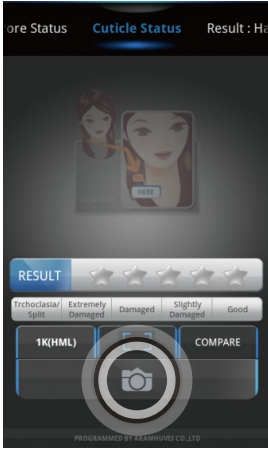

① Touch  to activate camera.



② Touch  to take image.

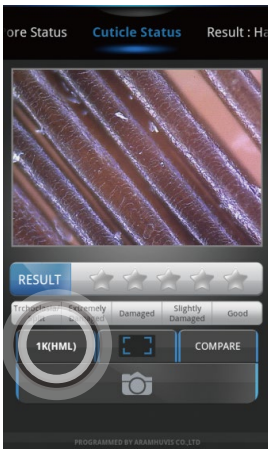

③ Touch "1K(HML)" to 1000x mode.
Touch  to full image.
Touch "COMPARE" to compare mode.

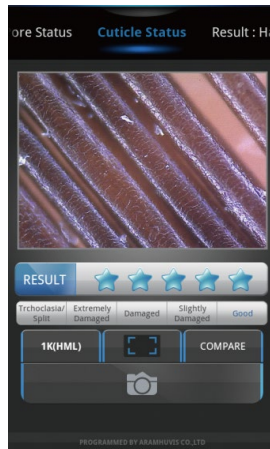

④ Check the result.

Application

Result

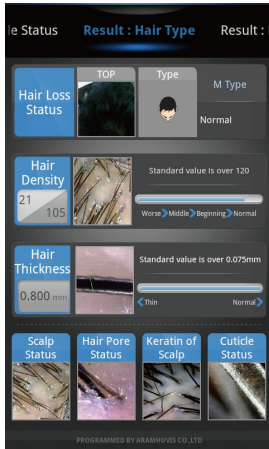

1 Fling the screen to go to next page.

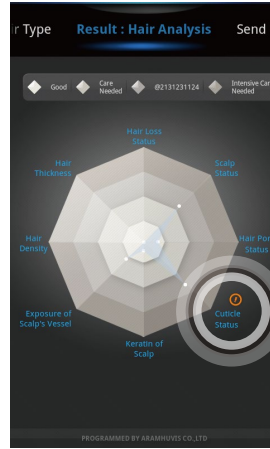

2 Touch  icon.

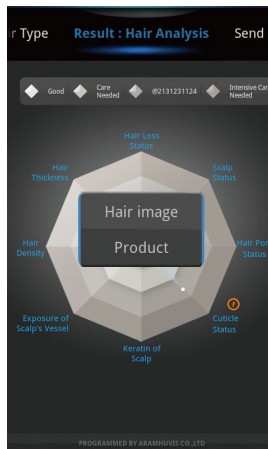

3 Touch  to show "Hair image" and "product".

Application

Send Result - Email

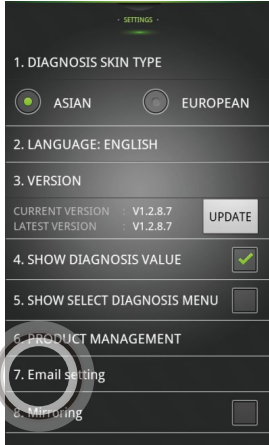

1 In SETTINGS page, touch "7.Email setting".

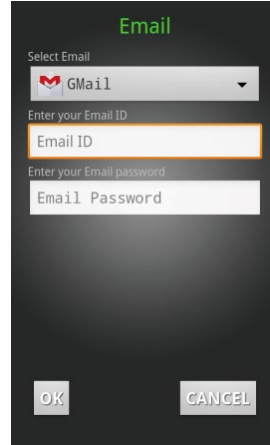

2 Touch "Mail account".

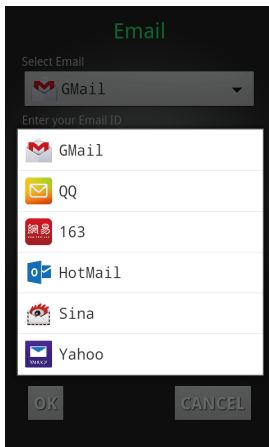

3 Select the mail account to register on the list.

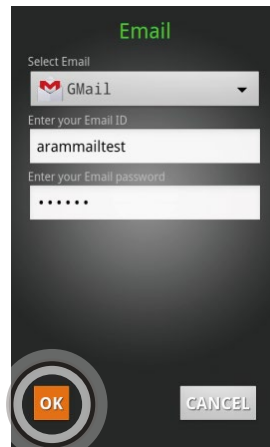

4 After select the mail account, please Input the ID only and password. Then touch "OK".

Application

Send Result - Email

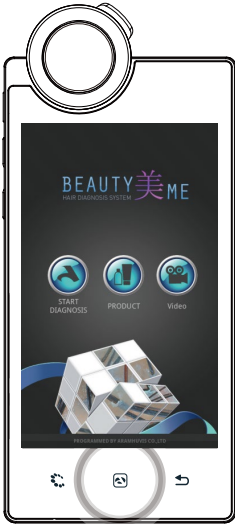

1 Press  button.



2 Touch  button.

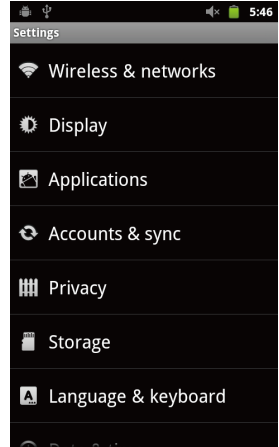

3 Touch "Wireless & networks".

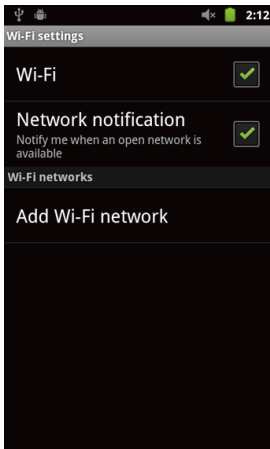

4 Check the square box.

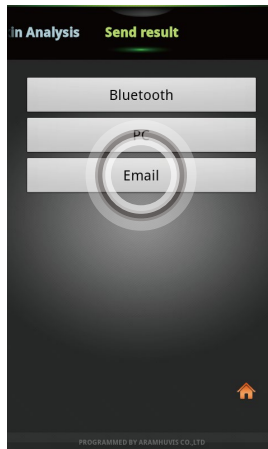

5 In "Send result" page, touch "Email".

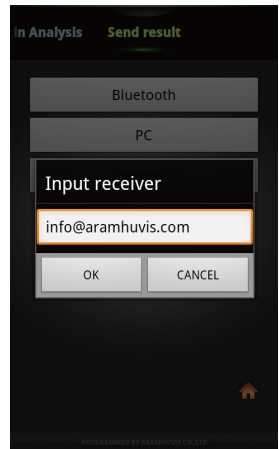

6 "Receiver"s email address will be appeared with your CRM information. Otherwise, input the email address.

Application

Send Result - Mirroring

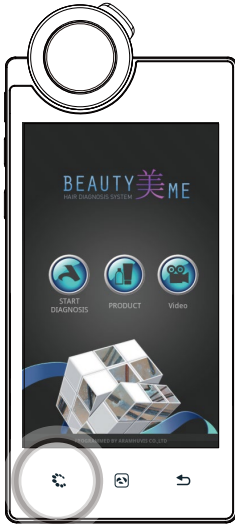

1 Press refresh button.

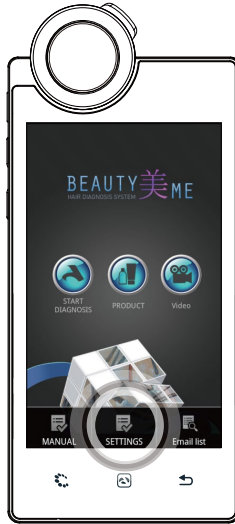

2 Touch "SETTINGS".

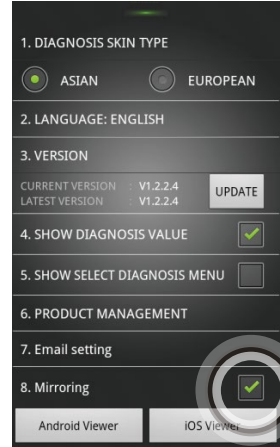

3 It is able to connect to "Android Viewer" & "iOS Viewer" system when AP success is shown up on the screen.

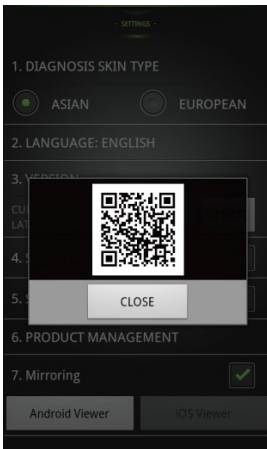

4 With your mobile device, capture QR code. Then program will be installed.

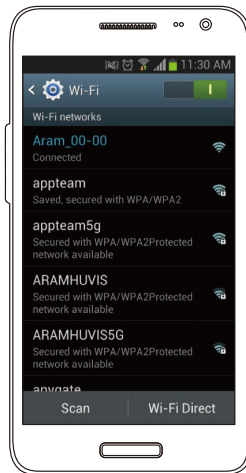

5 In your mobile device go to Wi-Fi setting. Then find "ARAMHUVIS" code and connect it.

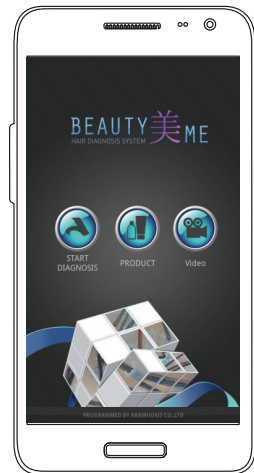

6 Mirroring system is started.

Troubleshooting & FAQ

1 I cannot turn on the device.

Connect and charge the device (or the battery) using the adaptor provided the supplier. (The battery charging indicator will be shown on the system main page.)

2 I cannot power on the device even the battery is still full.

The battery might be dislocated on the device. Please separate the battery from the device and put it on, and then power on again.

3 The battery is not charging very well.

Separate the battery from the device and put it on again.
Check the connection among a device, a battery and a charger.
A battery cannot be charged if there is an alien substance on the charging port.
In this case, please use the device after cleaning the charging port of the device or check whether the sticker is attached on charging port.

4 The using time of the battery is different from the manual.

The battery using time will be shorten if you put the charged battery in a low or high temperature. The battery using time varies in service type, using environment, using period of the battery. The battery is consumed without using the device, and the battery using time will be shorten if you use additional functions of the device.

5 The device turns on but the diagnosis doesn't work.

Check the smart card is correctly inserted (SD card slot on the button of the device.)

6 There are dust on the device.

Clean the dust by using a smooth fabric. Do not use benzene, alcohol, and a synthetic detergent.

7 The screen is frozen and the keys not working when using the device.

Separate the battery from the device and put it on again.
If the device is still not working please contact to the customer service center.

8 A "force close" message appears on the screen.

The repetition of commands can trigger a bug. Sometimes there may be a brief delay before the command is completed. Do not repeat/multiply the tasks as the device will no longer be able to follow them.

9 I cannot connect to Wi-Fi.

Check the connection status on setting page.
Try to connect to another Wi-Fi.
Bluetooth : check the pairing status and try to re-pair the device with host device.

Troubleshooting & FAQ

10 The touchscreen doesn't react to my finger commands.

Before using for the first time remove the protective plastic film.

11 I cannot connect to Blue-tooth.

Make sure to use the Bluetooth hosting devices that have Bluetooth certified with the logo. You may need an external Bluetooth dongle for those devices that do not have Bluetooth feature. bring the device to closer with the Bluetooth hosting device.

Try to re-pair the device with host device.

The password of pairing is "0"(number).

* Blue-tooth function is not allowed to use in IOS device without APPLE'S official permission.

12 The screen was turned off.

Press the on/off button to turn on the screen.

The device has a power save function that turn the screen off after 1 minute.

For the setting, please refer to Page 8.

13 I can see the black screen only during measurement.

Check the LED light inside lens on the head part when you try to measurement.

If you cannot see the light, please contact the customer service via email or phone call.

14 The image is not clear.

Tap the screen while capturing focus.

15 I cannot update the diagnosis application.

Check the network connection. The update process can be done after connecting to Wi-Fi.

Warranty

- 1 The product undergoes strict quality management and inspection process before production and introduction to market.
- 2 In case of functional or operational defect occurs under normal condition of use within 10 days after purchase, we will repair it for free or replace in new product.
- 3 When this product goes out under the normal use, we will repair it free of charge under warranty.
- 4 Please keep the warranty card when you ask for repair service.
- 5 Customer needs to pay repair charge after warranty runs out.
- 6 For this product, warranty period is 14 months from the Invoice date.
- 7 Cost
Within warranty : Sending delivery(Buyer), repair cost and returning delivery(Aram)
 - If the product is broken by user's fault, repair cost could be charged.After warranty : Sending delivery and repair cost(Buyer), returning delivery(Aram)
- 8 How to send :
 - As sending a present from person to person by EMS or FEDEX.
(Do not write the company name)
 - Total value should be under US \$ 99.(Write non-commercial value)

Warranty

Service request form			
Date of purchase	/	/	Company
Contact Person			
Address :			
Tel :			
Product name, serial No :			
Problems :			

Shipping address:

801-ho , 560 Dunchon-daero, Jungwon-gu Seongnam-si Gyeonggi-do 13230 KOREA.

E-mail : support@aramhuvis.com

Tel : +82 70 4687 1712 / Fax : +82 31 732 6330

Memo
